













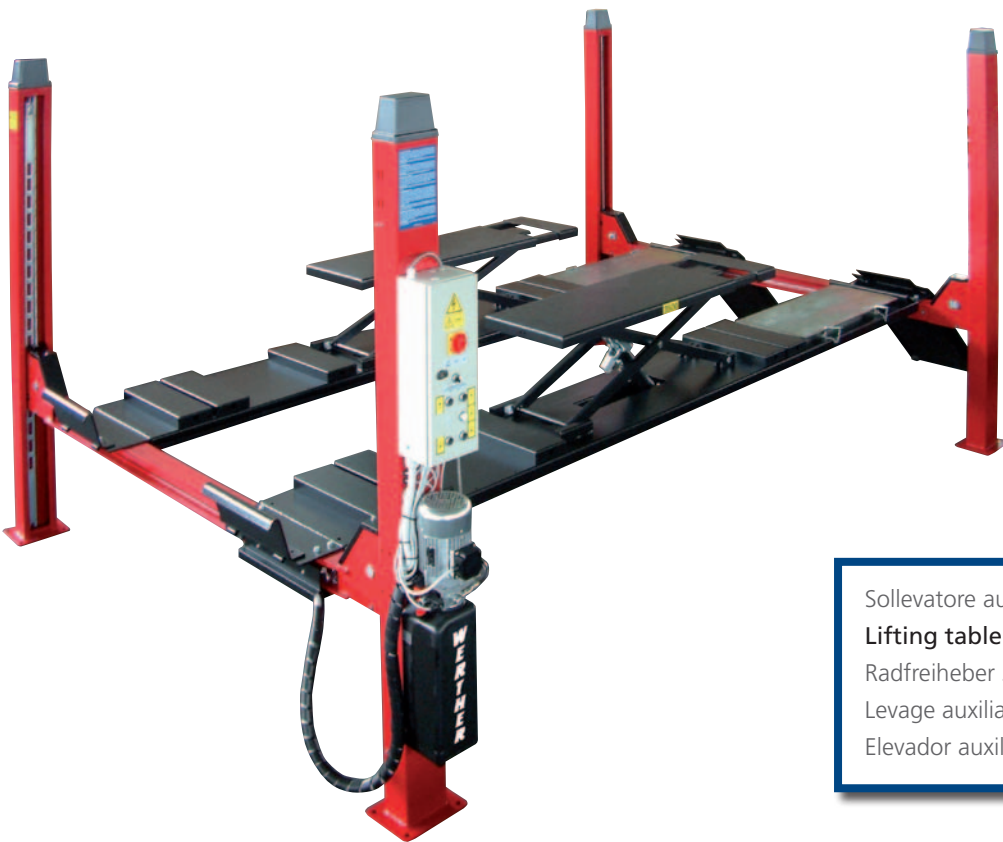





-  Sollevatore elettroidraulico a 4 colonne con incavi anteriori e piastre oscillanti posteriori per allineamento ruote e sollevatore ausiliario incorporato
-  **Electro-hydraulic 4 post lift with front recesses and rear slipping plates for wheel alignment and built in lifting table**
-  Elektrohydraulische 4-Säulen-Hebebühne mit vorderen Aussparungen und hinteren Schiebeplatten für die Achsvermessung und eingebautem Radfreiheber
-  Pont élévateur électro-hydraulique à 4 colonnes avec encastres avant et plaques arrière pour géométrie et levage auxiliaire incorporé
-  Elevador electro-hidráulico de 4 columnas con asientos delanteros y platos oscilantes traseros para alineación de las ruedas y Elevador auxiliar incorporado

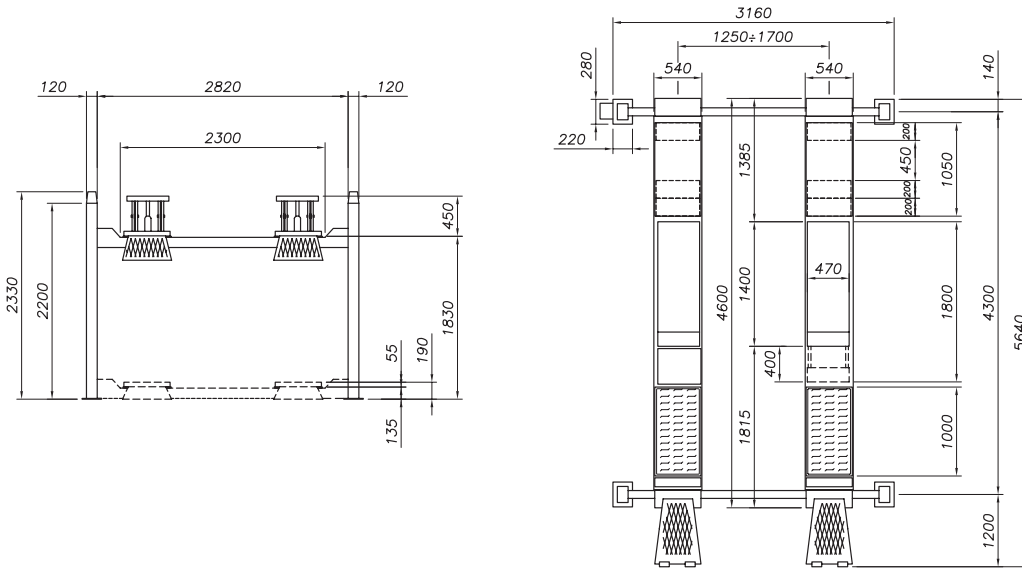

Sollevatore ausiliario da 3,5 t
Lifting table with 3,5 t capacity
 Radfreiheber 3,5 t Tragkraft
 Levage auxiliaire capacité 3,5 t
 Elevador auxiliar con capacidad de 3,5 t

-  Super - ribassato • Alta velocità di sollevamento • Sicurezza in caso di rottura fune • Sicurezza idraulica in caso di sovraccarico • Valvola di controllo velocità di discesa • Valvola sicurezza in caso di rottura tubo idraulico • Comando uomo presente 24 Volt • Comando automatico di discesa • Insonorizzazione sicurezze • Segnale acustico ultimo tratto di discesa
-  **Low profile • High lifting and descent speed • Safety device in case of cable breakage • Overload safety-device • Descent control valve • Safety-valve in case of sudden loss of pressure • Dead man controls 24V • Automatic descent control • Soundproof safety devices • "Buzzer" on last portion of descent**
-  Niedrige Auffahrhöhe • Hohe Hub- und Senkgeschwindigkeit • Seilbruchsicherung • Rohrbruchsicherung • Senkregelventil • Hydraulische Überlastsicherung • 24 V- Totmannschaltung • Autom. Senksteuerung • Schallgedämpfte Sicherheitsklinken • Akustisches Signal im letzten Teil der Senkbewegung
-  Surbaissé • Grande vitesse de levage et descente • Sécurité en cas de rupture du câble • Sécurité hydraulique en cas de surcharge • Vanne de contrôle descente • Vanne de sécurité hydraulique en cas de rupture de tuyauterie • Commande de type homme mort 24V • Commande automatique de descente • Insonorisation des sécurités • Signal sonore sur la dernière partie de descente
-  Súper-bajo • Alta velocidad de elevación • Seguridad en caso de rotura cable de acero • Seguridad hidráulica contra la sobrecarga • Válvula de control velocidad descenso • Válvula de seguridad en caso de rotura del tubo hidráulico • Mandos de hombre presente, 24V • Mando automático de descenso • Insonorización de seguridades • Señal acústica último tramo de descenso



 Dati tecnici	 Technical data	 Technische Eigenschaften	 Caractéristiques techniques	 Datos técnicos	
Portata	Capacity	Tragfähigkeit	Capacité	Capacidad	4.000 kg
Peso	Weight	Gewicht	Poids	Peso	1200 kg
Salita/Discesa	Lifting/descent	Hub/Senkzeit	Levage/descente	Subida/Bajada	30 s
Altezza di sollevamento	Lifting height	Hubhöhe	Hauteur de levage	Altura de elevación	1830+450 mm
Motore	Motor	Motorleistung	Puissance moteur	Motor	3,0 kW - 3 ph 230 400V/50 Hz

Funzionamento: Elettroidraulico • **Function: Electro-hydraulic** • Funktionsweise: Elektrohydraulisch • Fonctionnement: Electrohydraulique
 • Funcionamiento: Electro-hidráulico

Sollevatore ausiliario da 3,5 t • **Lifting table with 3,5 t capacity** • Radfreiheber 3,5 t Tragkraft • Levage auxiliaire capacité 3,5 t
 Elevador auxiliar con capacidad de 3,5 t

 **Opzioni**  **Optionals**  **Sonderzubehör**  **Options**  **Opcionales**



Piatti Rotanti
 Radius plates
 Drehplatten
 Plaques pivotantes
 Platos giratorios

Esecuzione con motore monofase • Kit illuminazione • Carter protezione centralina
Single-phase motor • **Illumination kit** • **Cover for control unit**
 Ausführung mit Einphasenmotor • Beleuchtungsset • Abdeckung für Hydraulikaggregat
 Moteur monophasé • Kit d'éclairage • Carter protection centrale hydraulique
 Motor monofásico • Kit de iluminación • Cubierta protectora para la centralita